

KaVo Primus® 1058

Tried, tested and truly trusted.



KaVo. Dental Excellence.

Bestseller: the KaVo Primus® 1058. Reliable for generations.

Years of successful reliability, proven in clinical practice.

The KaVo Primus 1058 is one of the numerous success stories of KaVo, the German manufacturer renowned for quality. Why is this treatment centre so popular? Because of its incredible reliability and robustness. All components and functions are ideally harmonised with nothing superfluous. Your KaVo Primus 1058 therefore remains particularly economical. Thousands of dentists worldwide appreciate this already.



Table version: The KaVo Primus 1058 TM.
Height-adjustable patient chair from
395 mm to 780 mm

You know what you want. The ideal treatment design.

The bespoke solution for everyone – our three proven models.

When you choose the KaVo Primus 1058, you know what you want. A treatment centre has to work flawlessly, be reliable and produce convincing results. The KaVo Primus 1058 offers a well-thought-out dentist element, easy-to-use assistant element, automated hygiene system, ergonomic features for the dentist, assistant and patient, and a host of other specialised functions. The three models allow you to choose the right one for your dental practice and treatment philosophy.

Optimised access and efficient processes.

Whether you treat patients while sitting or standing: The ergonomic dentist element of your KaVo Primus 1058 provides reliable assistance. No uncomfortable stretching or twisting. You can always assume a natural body posture and perform unimpeded movements.

- **The table version.**
With the compact dentist element you can move more freely for perfect, ergonomic work in every treatment position.
- **The swing arm version.**
The handpiece instrument lies perfectly balanced in one's hand and the special tubing guidance system as well as the enclosed housing achieves simple, effective and hygienic infection-control.
- **The cart version.**
Enjoy the intuitive operation also with the cart version. Take advantage of the additional mobility of the dentist element and place it directly at your side if needed.



KaVo Primus 1058 S swing arm version



KaVo Primus 1058 C cart version



Here, dentists are in their element. Relaxed treatment, every day.

Every instrument that you need.

Depending on your individual treatment approach, we will assemble your dentist element precisely according to your specifications. You can freely configure five instrument holders*. The mounting module can be used for an intraoral camera. We would be glad to make any changes that you deem necessary at a later time. This allows you flexibility for the future.

* Your dealer will be happy to advise you.

Remove plaque efficiently, protect teeth and gingiva.

Ultrasonic scaler with KaVo care technology.

The PIEZO ultrasonic scalers PIEZOsoft and PiezoLED ensure high-precision and effective dental cleaning for your patients. KaVo CARE technology allows you to apply power extremely evenly and with optimum linear tip movement by means of a sinusoidal signal. Teeth and gingivae remain undamaged, even in delicate areas, due to the higher accuracy of your work.



PiezoLED: innovative KaVo care technology with intelligent feedback control for the highest standards of patient treatment.

It's always exciting at the cutting edge.

Specific patient treatments with PiezoLED ultrasonic scalers.

15 available tips cover all major dental applications: prophylaxis, periodontics, preparation and cleaning of implants. This way your calculus removal instrument becomes multi-skilled. The LED's circular illumination offer optimal viewing conditions for you and, in combination with the lightweight and ergonomic design, you always treat your patients under ideal conditions.



Double the dentist comfort with the KaVo Memospeed. Indication-related speed memory on three programmable levels for two dentists.

SMARTdrive takes you powerfully yet sensitively into the future.

The new SMARTdrive motor control with full torque and particularly vibration-free start-up characteristics, even in the low speed range of 100 rpm ensures precise and efficient work, saving valuable time. Due to the broader speed range, all straight and contra-angle handpieces may now be used in a more versatile manner, which extends the range of applications of each contra-angle handpiece.

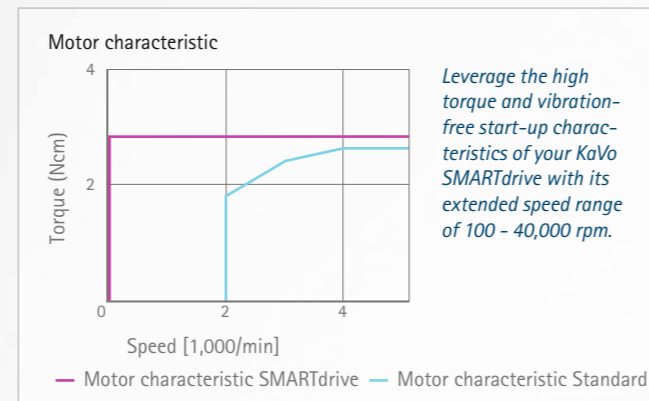

Leverage the high torque and vibration-free start-up characteristics of your KaVo SMARTdrive with its extended speed range of 100 - 40,000 rpm.

Tried and tested by millions of successful treatments. Supreme supine comfort for every patient.

A comfortable position means calm, relaxed patients.

Day after day, patients experience just how relaxing a visit to the dentist can be with the KaVo Primus 1058. This is afforded by the ergonomic seat recess in the patient's chair and the integrated lumbar support. The chair may comfortably accommodate children or patients with back problems, simply by employing the unique, integrated seat-height adjuster. Dentists will be impressed with the ergonomic positioning since comfortable patients naturally move less. This makes it easier for both the dentist and assistant to concentrate on their work. Safety and efficiency are therefore enhanced.



Enhanced sitting comfort thanks to the soft upholstery with an ergonomically shaped seat recess and integrated lumbar support.

The COMPACTchair frees up space.

If you are looking for a comfortable treatment chair with reduced dimensions for your practice, the COMPACTchair option for your KaVo Primus 1058 is the answer. It may be tilted to make it more accessible for older patients. It may be easily moved from the 80°, upright sitting position into the supine position. Talk to your patients while they are seated and then treat them while they are reclined.



Whether child or adult, the unique seat adjustments allow every patient to lie in relaxed comfort in every treatment situation.

COMPACTchair patient chair. Adjustable in height from 390 mm to 740 mm.



The dentist element and patient chair – main features and advantages for you:

- Ergonomic and relaxed working posture at all times
- More efficient treatment with everything directly accessible
- Comfortable soft upholstery with an ergonomically-shaped seat recess and integrated lumbar support
- Focused treatment thanks to relaxed patients

Support your team. The adaptable assistant element.

Now even more flexibility on your 1058 – Assistant's module r/l.

To make work for your dental assistant and yourself even more comfortable if you are left-handed or if you are working on your own, we can now offer an assistant's module with right/left swivel function for your KaVo Primus 1058.

Its double-jointed arm offers maximum freedom of movement across its entire reach. At the same time it leaves sufficient room for foot controller and treatment chair.

So that tall as well as short practitioners can work in optimal ergonomic positions, we also offer a 5 9/32 inch (135 mm) continuous height adjustment option for the assistant's module.

Exemplary working conditions for your entire team.

Your assistant now has everything within reach. Given its optimised swinging range, the assistant element of your KaVo Primus 1058 is always within grasp, and the optional adjustable height also promotes healthy, ergonomic treatment. Your employees therefore always have optimum access to the patient, and smooth, seamless procedures are guaranteed.

Foot control, PHYSIO Evo, assistant element – main features and advantages for you:

- Free hands and relaxed leg muscles with the KaVo foot control which moves laterally.
- Perfect ergonomics and optimal seating comfort provided by the KaVo PHYSIO Evo
- The KaVo PHYSIO Evo has a modern design and is available in attractive colours
- Healthy, ergonomic posture for your nursing assistant due to the pivotable and height-adjustable assistant element.
- Simple operation of the assistant's module through direct selection keys
- Maximum flexibility through right/left swivel function of the assistant's module

*Only useful functions with nothing superfluous:
The assistant element.*

Making life that much easier. Even more comfort with foot control and KaVo PHYSIO Evo.

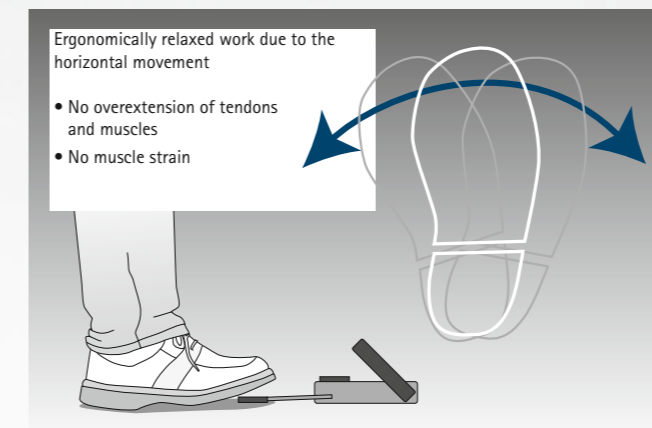

The foot control enables you to assume a healthy and natural leg position.

Keep your hands free for important things.

The less you touch, the more hygienic your work. The highly functional and ergonomic foot control makes this possible. During treatment, it gives you the support you need to focus and work hygienically in the buccal cavity. An efficient precaution against cross-contamination.

Relaxed lateral movement.

Instead of moving your foot up and down as on a car accelerator pedal, you pivot your foot horizontally with the KaVo Primus 1058. You do not have to continuously keep your leg muscles in tension to control and maintain constant handpiece speeds, and you can provide treatment in a relaxed manner. The foot control operates all of the functions of your instruments, chair and multimedia system.

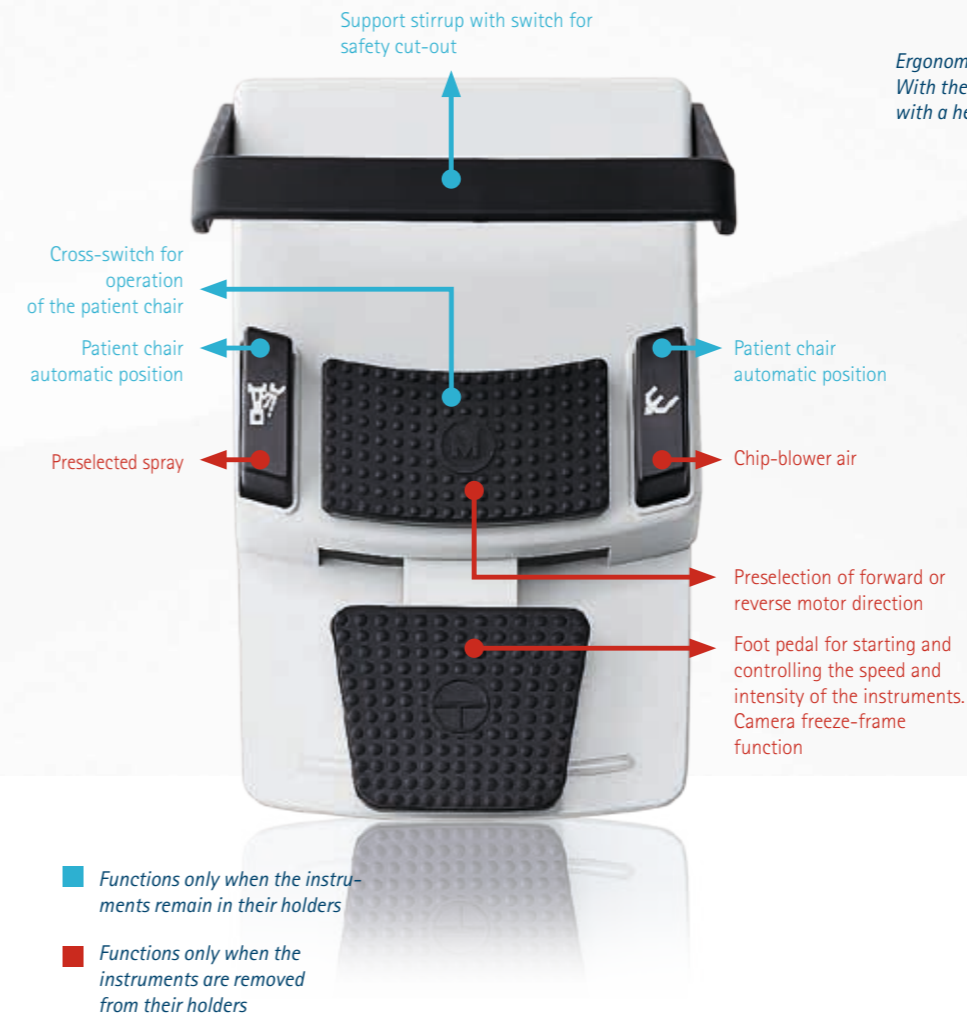

*Ergonomics and comfort in perfection:
With the KaVo PHYSIO Evo, you always sit with a healthy, natural posture.*



Easy, safe and quick. KaVo has perfected hygiene features.



Hygiene made simple: The continuous disinfection provided by KaVo OXYGENAL 6 reduces the propagation of algae and germs. Smooth surfaces and removable protective covers and instrument holders make cleaning easier.

Easy to clean components.

Your assistant will find it very easy to clean your KaVo Primus 1058. Important pieces such as the silicone mat and instrument holder are removable for disinfection. The spittoon bowl may also be removed and reprocessed in a washer-disinfector. All surfaces are designed to be easily and quickly cleaned. The time saved adds up to your benefit.

The HYDROclean function prevents downtime.

The automatic HYDROclean program of your KaVo Primus 1058 prevents clogging from blood and secretions, and controls the hydro-mechanical cleaning of the amalgam separation, suction and drainage systems. Together with KaVo DEKASEPTOL gel, it keeps your treatment centre in full working condition.

Save time with DEKASEPTOL Gel.

KaVo DEKASEPTOL gel is supplied pre-mixed and ready to use. This saves valuable time. DEKASEPTOL gel completely wets the lumens of suction hoses and systems and adheres to the contaminated regions, instead of merely passing straight through.



Automated protection. Reliable hygiene.

Prevent cross-contamination.

To prevent contaminated water from being drawn back into your KaVo Primus 1058, all KaVo instruments and motors have an intelligent, reflux prevention systems. These systems reliably protect your entire water supply and hence you, your team and your patients.

Rinsing program according to RKI guidelines.

The Robert Koch Institute has specified the standards that a dental treatment centre must meet, to reliably prevent the spread of infection. The automated rinsing program of your KaVo Primus 1058 meets, or exceeds these standards before starting work and after each patient.

The water block meets DVGW requirements.

The free water inlet of your KaVo Primus 1058 prevents contaminated reflux into your practice water supply system. Your dental treatment centre thereby also meets the stringent requirements of the German association „Deutsche Vereinigung des Gas- und Wasserfaches e. V. (DVGW)“.

Time savings in hygiene – main features and advantages for you:

- State-of-the-art hygiene standards (according to RKI)
- Automatic hygiene functions to save time
- HYDROclean function to prevent coagulation of protein in the internal suction lines
- Optional, permanent and intensive disinfection for continuous reduction of algae and other micro-organisms
- Removable parts for faster and improved hygiene
- Safety for dentist, assistants and patients



Filter system: Just pinch the hygiene grip between thumb and forefinger then pull out, to quickly and easily extract and clean (or replace) the intake filter.



Proven over 30,000 fold. Protects your investment for the future.

100% tested, proven – thousands of times over.

To ensure that your KaVo Primus 1058 works continuously and reliably, we comply with stringent standards in all areas of manufacturing and material quality. All assemblies and components are precisely machined, perfectly tailored to each other and designed to resist maximum stress, whilst still providing maximum longevity

We perform comprehensive, quality control tests to ensure that each product truly satisfies every claim and requirement. For every dental treatment centre. You are secure from failures or other expensive inconveniences.

More than 30,000 KaVo Primus 1058 treatment centres, in daily use around the world, offer a clear testimony that you will find "made-in-Germany KaVo quality", more than satisfactory.

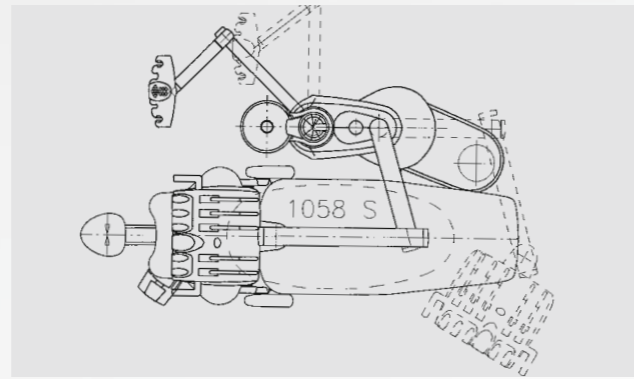

Perfectly designed from the ground up – Outline of the KaVo Primus S.



Red Dot Award: The design of your KaVo Primus 1058 takes into account and supports ergonomic, efficient procedures. The „Red Dot“ stands for a high degree of innovation, functionality and demonstrable quality.



Looking good. Cost-efficient from every angle.

A flexible "service box" saves time and money.

We have taken great care to ensure that your KaVo Primus 1058 may be quickly and easily installed. Practice alterations are reduced, and you may use existing, service connection points. Only KaVo offers this significant advantage.

Classic design for your future.

Choose the timeless design of the KaVo Primus 1058. This gives your employees and patients a forward-looking sense of reliability for years to come. A classic dental treatment centre.

Take your choice of colours and optional accessories.

Ideally adapt your KaVo Primus 1058 to your needs with the extensive range of colour choices and numerous accessories.

Economy and advantages – main features and advantages for you:

- Economical to purchase
- Cost-efficient operation
- Low failure rate and long life
- Time-saving procedures
- Very easy to integrate and combine with other devices
- Wide range of products attuned to your treatment concept
- Upgradeable systems

Paint metallic

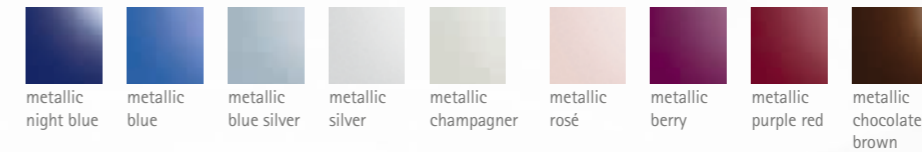

Paint uni

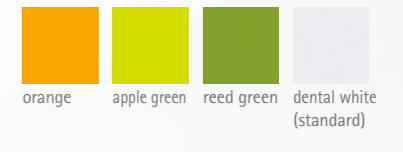

Upholstery colour

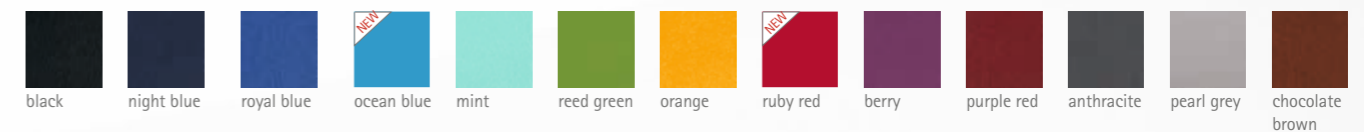

Small X-ray viewer



Panoramic X-ray viewer

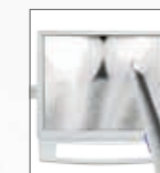

ERGOcom light + ERGOcam



EDI operating light



KaVoLUX 540 LED operating light



Working chair KaVo PHYSIO Evo



PiezoLED Ultrasonic scaler



PIEZO.soft Ultrasonic scaler



Special mounting module ERGOcam

Your complete line. Options for the KaVo Primus® 1058.

	TM	S	Cart		TM	S	Cart
Patient chair	●	●	●	Assistant element	●	●	●
Standard	x	x	x	with Comfort control unit	●	●	●
COMPACTchair	x	x	x	Spray mist suction	●	●	●
Height-adjustable seat	●	●	● ¹	Saliva ejector	●	●	●
Soft upholstery	●	●	●	Second saliva ejector	○	○	○
				Triple-function handpiece	○	○	○
Backrest	●	●	●	Multifunctional syringe handpiece	○	○	○
Comfort	x	x	x ²	Satelec LED curing light	○	○	○
Progress	x	x	x	Tray holder for 1 standard tray	○	○	○
				Tray holder for DIAGNOdent	○	○	○
Headrest	●	●	●	Swivelling assistant element	●	●	●
Double-jointed headrest rotary knob	x	x	x	Swivelling and height-adjustable assistant element	○	○	○
Double-jointed headrest push button	x	x	x ²	Assistant's module with right/left swivel function	○	○	○
				Assistant's module with right/left swivel function and continuous height adjustment	○	○	○
Arm rest				Suction tube guide	○	○	○
Right	●	●	● ³	Selective base	○	○	○
Left	●	●	● ³				
				Device body	●	●	●
Dentist element	●	●	●	Porcelain spittoon bowl	●	●	●
1. Turbine tube	●	●	●	VACUstop	●	●	●
1. KL-Motor 701	x	x	x	Permanent disinfection	●	●	● ⁶
1. KL-Motor 703 LED	x	x	x	Intensive disinfection	○	○	○
Triple-function handpiece	●	●	●	HYDROclean (rinsing system)	●	●	●
Multifunction handpiece	○	○	○	Warm water heater	○	○	○
2. Turbine tube	○	○	○				
2. KL-Motor 701	○	○	○	Supply system	●	●	●
2. KL-Motor 703 LED	○	○	○	DVGW water block	x	x	x
COMFORTdrive	○	○	○	Water block, compact	x	x	x
SMARTdrive	●	●	●	DVGW water bottle	x	x	x
PIEZOsoft	○	○	○	Low-pressure regulator	○	○	○
PiezoLED	○	○	○	Additional device connection	○	○	○
Memospeed display indicator or small X-ray viewer	○	○	○ ⁴				
Panoramic X-ray viewer (on the light post)	○	○	○ ⁵	Disposal system	●	●	●
Panoramic X-ray viewer (on the table element)	-	-	○ ⁴	External suction	x	x	x
Tray holder for US tray	x	x	x	DÜRR amalgam separator	x	x	x
Tray holder for 1 standard tray	x	-	x	DÜRR automatic separator	x	x	x
Tray holder for 2 standard trays	○	○	-	Solids collector	x	x	x
Spray heating for instruments	○	○	○				
Physiological saline solution	○	-	-	Miscellaneous			
ERGOcam	○	○	○	KaVo PHYSIO Evo	○	○	○
				KaVoLUX 540 LED	○	○	○
				EDI operating light	○	○	○
				Light mounting post	○	○	○
				Patient service box	○	○	○
				Service table 1568	-	-	○
				ERGOcam light	○	○	○
				DEKASEPTOL Gel basic set	●	●	●
				Hygiene kit	○	○	○



● Standard equipment ○ Optional equipment x Must be selected - Not available

- 1 Not deliverable with the COMPACTchair patient chair
- 2 Only with the COMPACTchair
- 3 Optional with the COMPACTchair patient chair
- 4 Not suitable for installation under a worktop
- 5 Not together with Multimedia
- 6 Only with DVGW water block and DVGW water bottle



KaVo. Dental Excellence.